

Diffusers (ATD)

Wozair Louvre Faced Diffusers are mounted horizontally in ceilings or on to duct flanges.



Diffusers

Wozair manufacture a range of all Stainless Steel louvre faced diffusers designed to produce 1-, 2-, 3- or 4-way directional air patterns.

Frames are flared angle section with welded corners. Diffuser blades are welded into the frame, although removable cores are available.

Optional integral opposed blade dampers are available with single skin blades adjustable through the front face of the diffuser. The gear ratio ensures that airflow cannot move the blade setting.

Technical Information

Minimum Duct Size

150 x 150mm

Maximum Duct Size

600 x 600mm

Width and height dimensions available in 75mm increments

Materials of Construction

Casing and Flanges:

Materials

Stainless Steel 304L/316L (1.4307/1.4404)

Thickness

1.5 - 3.0 mm thick

Fully welded

14 Core Style Configurations

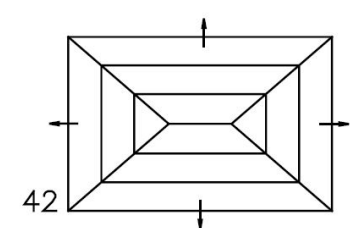
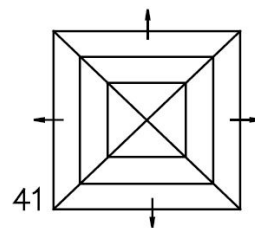
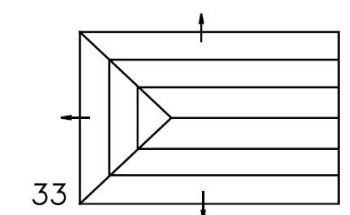
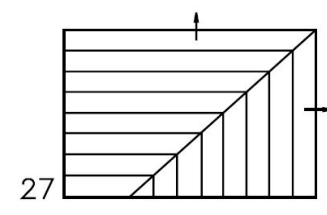
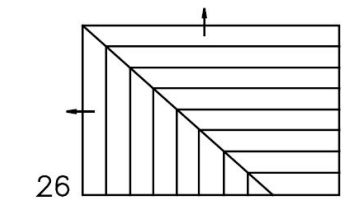
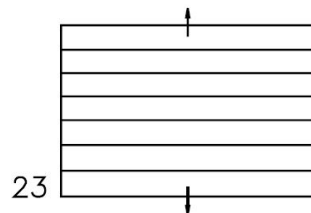
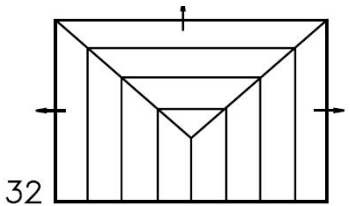
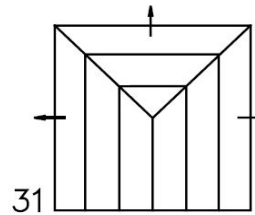
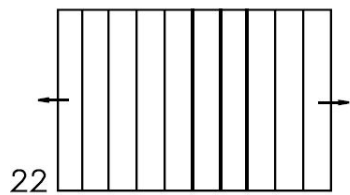
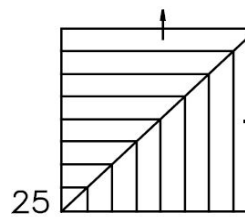
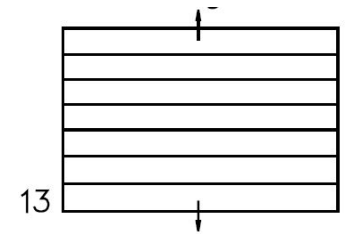
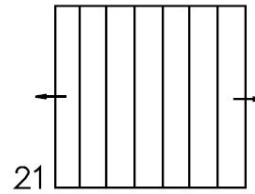
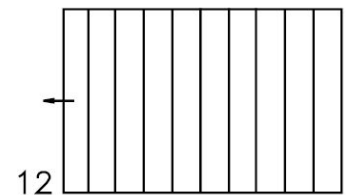
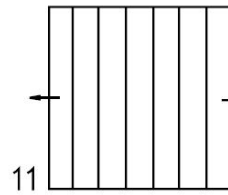

Performance data available on request

Dimension Drawing

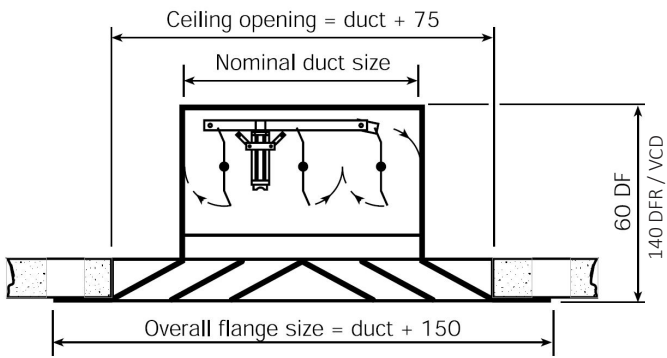

Ordering

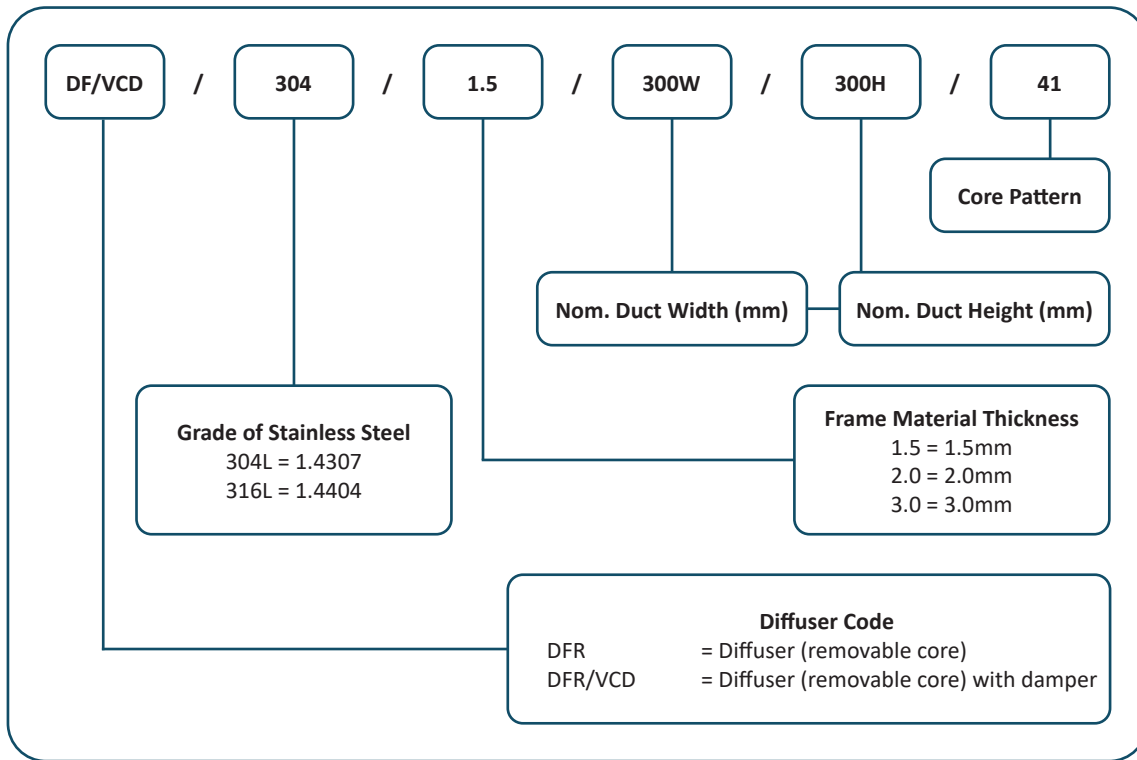

Wozair Limited

Grosvenor Road
Gillingham Business Park
Gillingham
Kent
ME8 0SA
United Kingdom

Phone +44 (0)1634 790 336

Email hvac@wozair.com

Wozair (USA) Ltd

3601 North Loop
336 West
Conroe
Texas
77304
United States of America

Phone +1 936 521 5990

Email houstonhvac@wozair.com

Wozair (Asia) Pte Ltd

2 Venture Drive
8-23 Vision Exchange
608526
Singapore

Phone +65 6890 6506

Email hvac@wozair.com.sg

Wozair Middle East

Office 202
LOB 17 Building JAFZA
Next to Gate 4
Dubai
P.O. Box 262404
United Arab Emirates

Phone +971 (0) 4 887 0147

Email dubaihvac@wozair.com